

Indication type only, Various sizes

■ Features

- Various size
: W48×H24, W72×H36, W48×H48, W48×H96,
W72×H72, W96×H96mm
- No output function, Indication only
- High accuracy measuring function
: F · S±0.3% or ±0.5%



⚠ Please read "Caution for your safety" in operation manual before using.

■ Ordering information

T 3 S I - N 4 N P 4 C

Item	Digit	Size	Sub output mode	Control method	Power supply	Control output	Sensor input type	Temperature range	Unit	C	°C		
									0	-99~199, -99.9~199.9, -99.9~99.9			
									1	0~99.9			
									2	0~199			
									4	0~399			
									5	0~500			
									8	0~799			
									A	0~999			
									C	0~1200			
									F	600~1600			
									P	Pt100Ω			
									J	J(IC)			
									K	K(CA)			
									R	R(PR)			
									Item	Digit	Size	Sub output mode	Control method
X	12-24VDC												
3	110/220VAC 50/60Hz												
4	100-240VAC 50/60Hz												
Item	Digit	Size	Sub output mode	Control method	Power supply	Control output	Sensor input type	Temperature range	Unit	Temperature range	Control method	N	No control function
												I	Indicator
												N	DIN W48×H24mm
												Y	DIN W72×H36mm
												W	DIN W96×H48mm
												S	DIN W48×H48mm
												H	DIN W48×H96mm
M	DIN W72×H72mm												
L	DIN W96×H96mm												
Item	Digit	Size	Sub output mode	Control method	Power supply	Control output	Sensor input type	Temperature range	Unit	Temperature range	Control method	3	3 Digit
												4	4 Digit
Item	Digit	Size	Sub output mode	Control method	Power supply	Control output	Sensor input type	Temperature range	Unit	Temperature range	Control method	T	Temperature

※ See C-67 about sensor temperature range for selection.

(A)
Counter

(B)
Timer

(C)
Temp.
controller

(D)
Power
controller

(E)
Panel
meter

(F)
Tacho/
Speed/
Pulse
meter

(G)
Display
unit

(H)
Sensor
controller

(I)
Switching
power
supply

(J)
Proximity
sensor

(K)
Photo
electric
sensor

(L)
Pressure
sensor

(M)
Rotary
encoder

(N)
Stepping
motor &
Driver &
Controller

(O)
Graphic
panel

(P)
Field
network
device

(Q)
Production
stoppage
models &
replacement

T3NI/T4YI/T4WI/T3SI/T3HI/T4MI/T4LI

Temperature range for each sensor

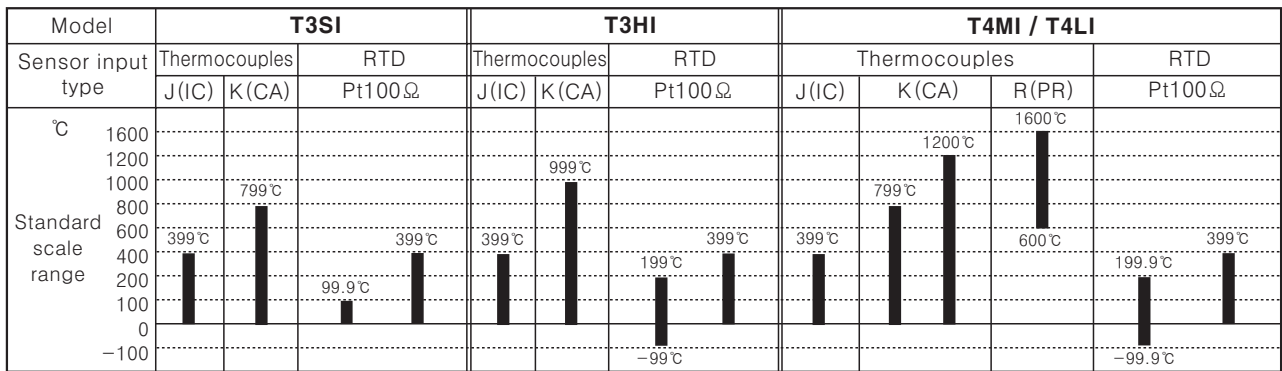
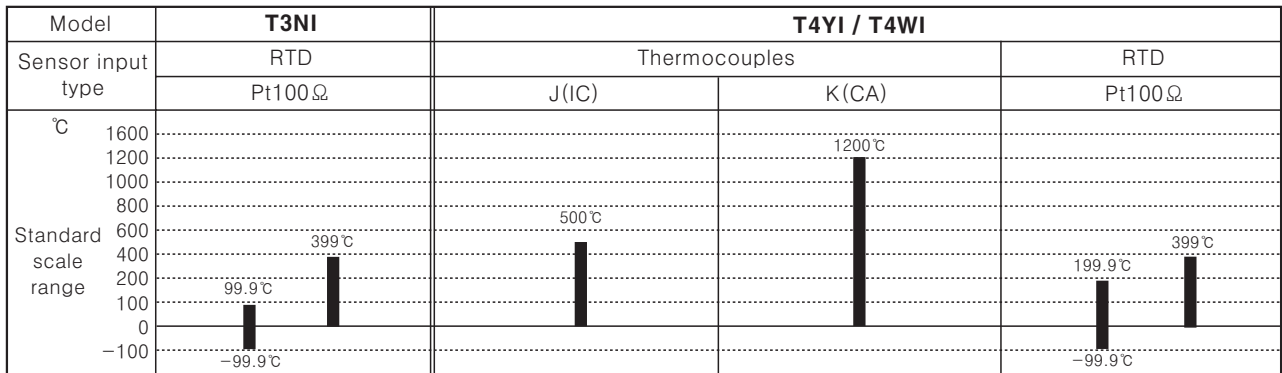

*In case input sensor is R(PR) type, it is not available to perform correct control under 600°C.

Specifications

Model	T3NI	T4YI	T4WI	T3SI	T3HI	T4MI	T4LI
Power supply	12-24VDC	100-240VAC 50/60Hz	110/220VAC 50/60Hz	100-240VAC 50/60Hz	110/220VAC 50/60Hz		
Allowable voltage range	90 ~ 110% of rated voltage						
Power consumption	2W	3VA					
Display method	7 Segment LED Display						
Character size	W5×H8mm	W9.8×H14.2mm		W4×H8mm	W6×H10mm	W7.2× H9.8mm	W9.5× H14.2mm
Display accuracy	F·S ± 0.3% rdg ± 1digit	F·S ± 0.5% rdg ± 1digit					
Sensor input	Pt100Ω	Thermocouples (T.C): K(CA), J(IC), R(PR) / RTD : Pt100Ω					
Input line resistance	Max. 5Ω per a wire	Thermocouples : Max. 100Ω / RTD : Max. 5Ω per a wire					
Insulation resistance	Min. 100MΩ (at 500VDC mega)						
Dielectric strength	2000VAC 50/60Hz for 1 minute						
Noise strength	±500V	±1kV the square wave noise (pulse width: 1μs) by the noise simulator					
Vibration	Mechanical	0.75mm amplitude at frequency of 10 ~ 55Hz in each of X, Y, Z directions for 1 hour					
	Malfunction	0.5mm amplitude at frequency of 10 ~ 55Hz in each of X, Y, Z directions for 10 minutes					
Shock	Mechanical	300m/s ² (Approx. 30G) 3 times at X, Y, Z direction					
	Malfunction	100m/s ² (Approx. 10G) 3 times at X, Y, Z direction					
Ambient temperature	-10 ~ +50°C (at non-freezing status)						
Storage temperature	-20 ~ +60°C (at non-freezing status)						
Ambient humidity	35 ~ 85%RH						
Unit weight	Approx. 34g	Approx. 170g	Approx. 322g	Approx. 107g	Approx. 368g	Approx. 356g	Approx. 433g

*F.S is same with sensor measuring temperature range.

Ex) In case of using temperature is from -99.9 ~ 199.9°C, Full scale is 299.8.

Indicator Type

Connections

※RTD(Resistance Temperature Detector) : Pt 100Ω(3-wire type) ※Thermocouple : K, J, R

- (A) Counter
- (B) Timer
- (C) Temp. controller
- (D) Power controller
- (E) Panel meter
- (F) Tacho/ Speed/ Pulse meter
- (G) Display unit
- (H) Sensor controller
- (I) Switching power supply
- (J) Proximity sensor
- (K) Photo electric sensor
- (L) Pressure sensor
- (M) Rotary encoder
- (N) Stepping motor & Driver & Controller
- (O) Graphic panel
- (P) Field network device
- (Q) Production stoppage models & replacement

●T3NI

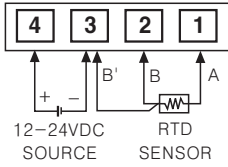

●T4YI

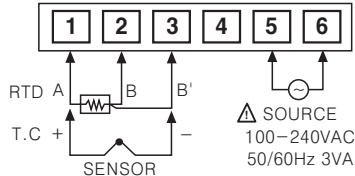

●T4WI

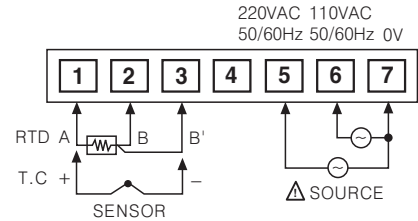

●T3SI

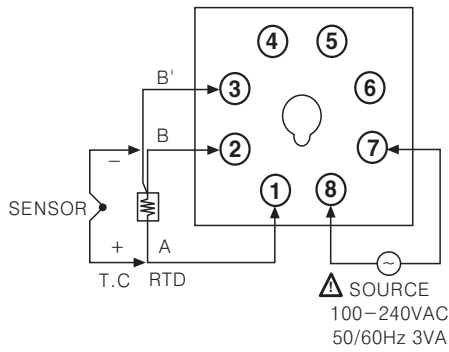

●T4MI

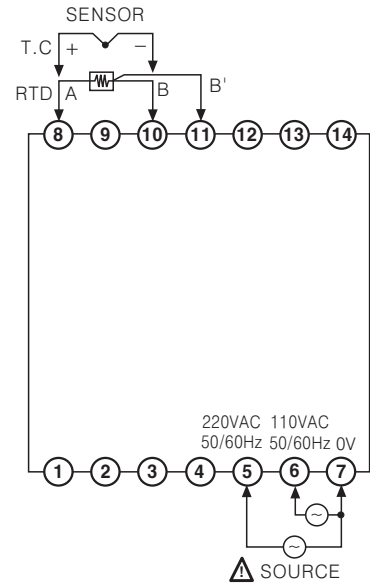

●T3HI

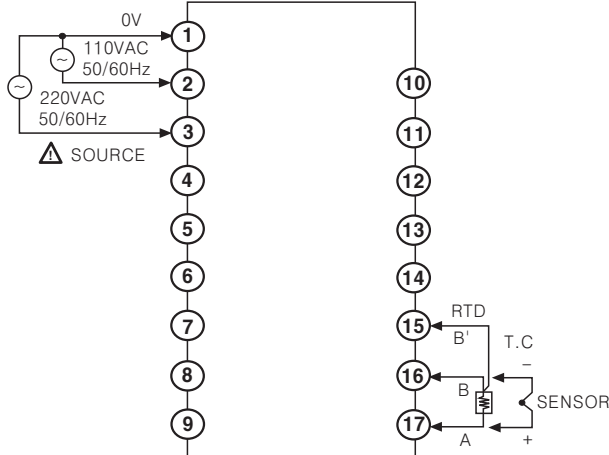

●T4LI

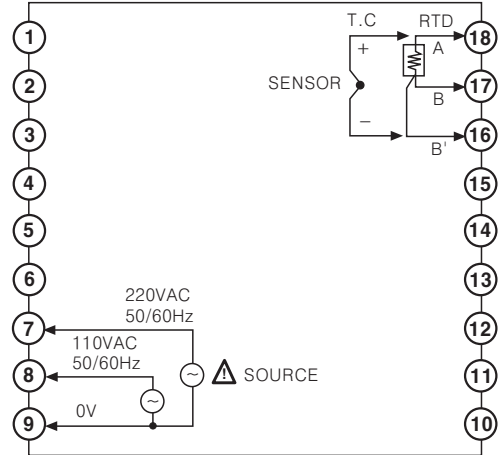

T3NI/T4YI/T4WI/T3SI/T3HI/T4MI/T4LI

■ Dimensions

○ T3NI

● Bracket

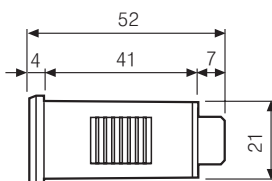
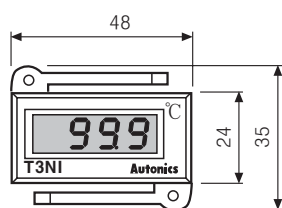
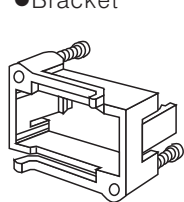

● Panel cut-out

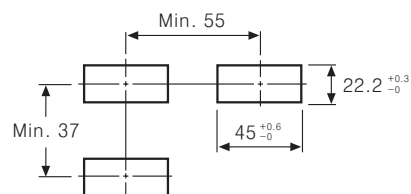

(Unit:mm)

○ T4YI

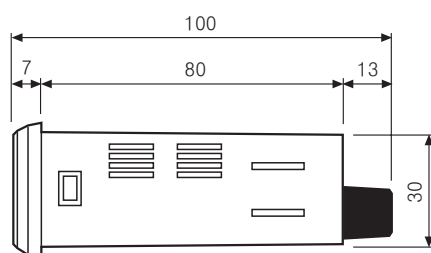
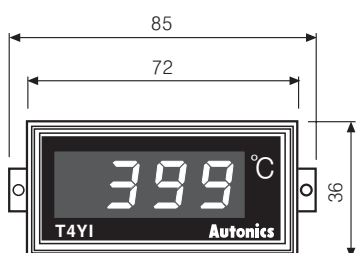

● Panel cut-out

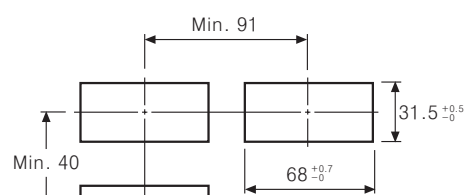

(Unit:mm)

○ T4WI

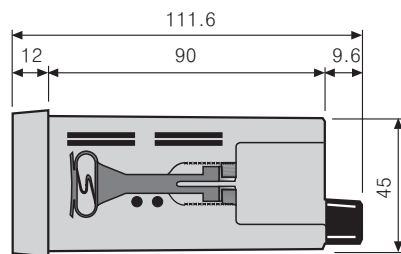
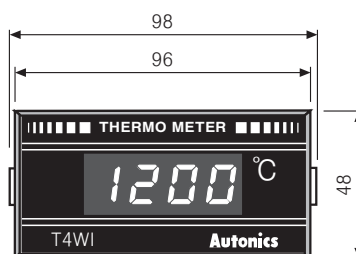

● Panel cut-out

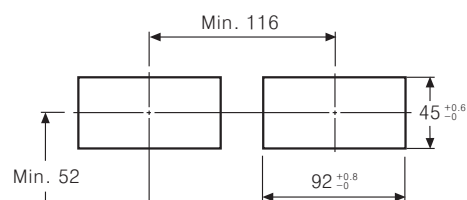

(Unit:mm)

○ T3SI

● Bracket

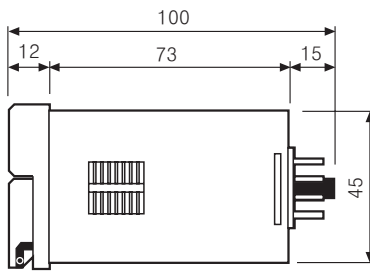
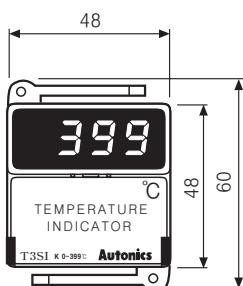
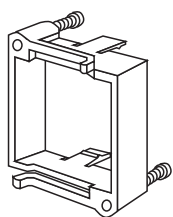

● Panel cut-out

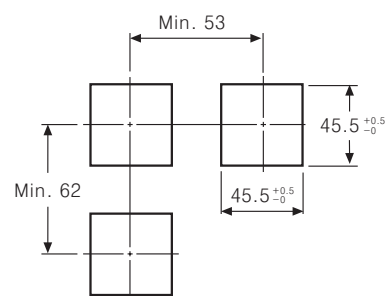

(Unit:mm)

Indicator Type

Dimensions

●T3HI

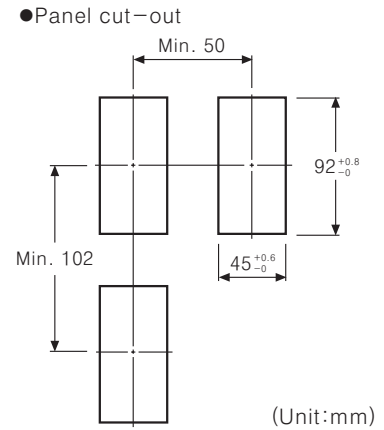
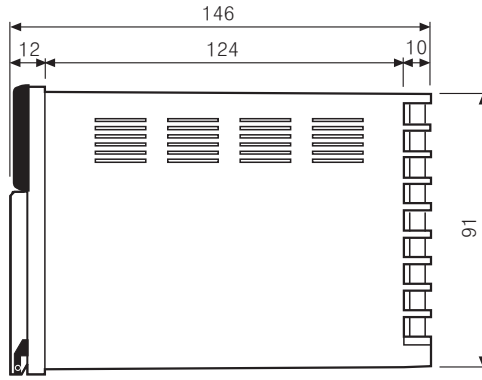
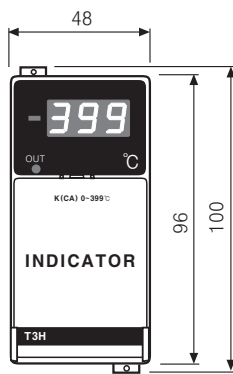

(Unit:mm)

●T4MI

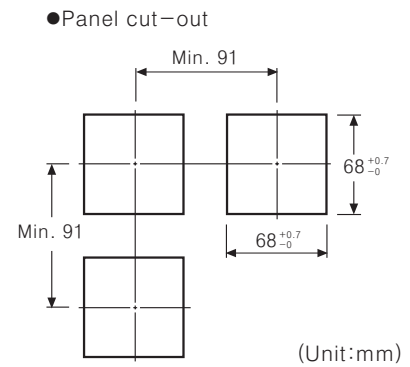
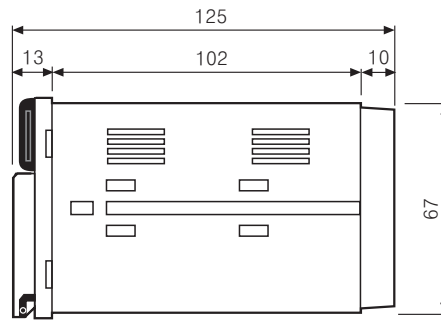
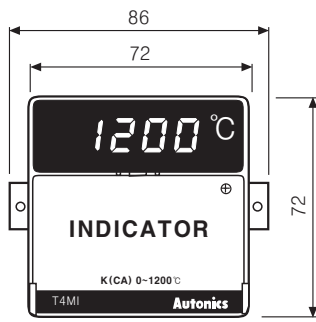

(Unit:mm)

●T4LI

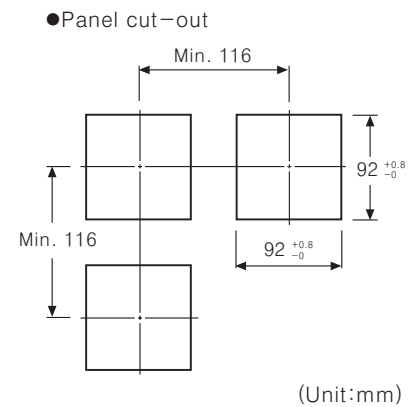
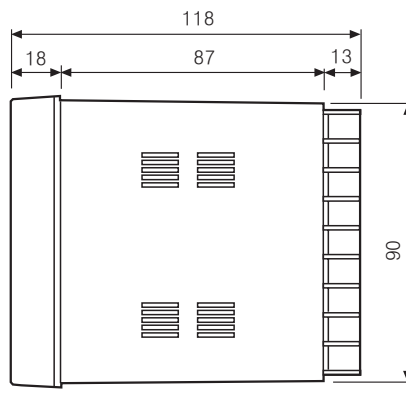
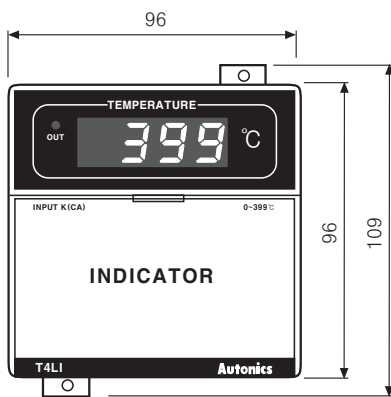

(Unit:mm)

Proper usage

○T3NI

- T3NI is used exclusively for measuring the internal and actual temperature of panel.
- Since the RTD type of T3NI is not produced, please check items before selecting the product.
- The power supply of T3NI is 12–24VDC and AC power is not produced.
- RTD requires to use Pt100Ω 3-wires type and same length and thickness of lead wire.

○The other items

- Please check a model name when choose the item since the thermocouple is marked the same sign with Pt100Ω. Ex) T4WI–N3NPO
- RTD requires to use Pt100Ω 3-wire type, and same length and thickness of lead wire.
- The extension wire of thermocouple must be used with the rated compensating wire or thermocouple strand.

(A)
Counter

(B)
Timer

(C)
Temp.
controller

(D)
Power
controller

(E)
Panel
meter

(F)
Tacho/
Speed/
Pulse
meter

(G)
Display
unit

(H)
Sensor
controller

(I)
Switching
power
supply

(J)
Proximity
sensor

(K)
Photo
electric
sensor

(L)
Pressure
sensor

(M)
Rotary
encoder

(N)
Stepping
motor &
Driver &
Controller

(O)
Graphic
panel

(P)
Field
network
device

(Q)
Production
stoppage
models &
replacement