

Weekly/Yearly Timer

W72×H72mm, Weekly/Yearly Timer

■ Features

- Easy to check and change the program setting.
- Customizable weekly or yearly unit time setting and control by user
- Includes Daylight Saving Time function
- 2 Independent control output.(Relay)
- Flush and Surface mounting are in one unit.
- Enable to mount on DIN Rail with base plate.



⚠ Please read "Caution for your safety" in operation manual before using.



■ Ordering information

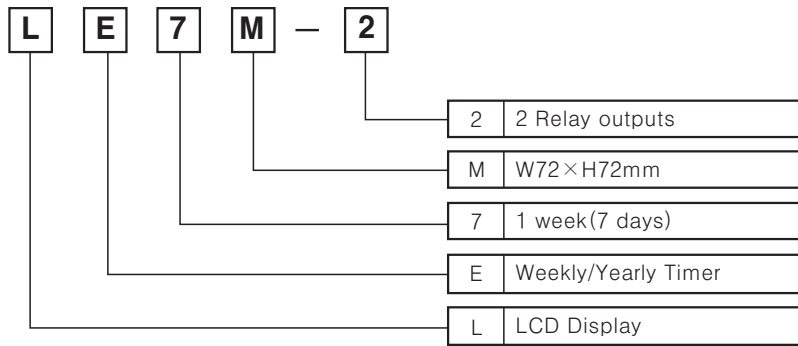

■ Specifications

Model		LE7M-2
Power supply		100-240VAC 50/60Hz
Allowable voltage range		90 ~ 110% of rated voltage
Power consumption		4.2VA
RETURN input		Short-circuit or open by switch or relay
Timing program		48 steps for weekly, 24 steps for yearly
Operation mode		ON/OFF mode, Cycle mode, Pulse mode
Temperature error		0.01% ±0.05sec
Mounting		Front panel, Surface, DIN rail
Time deviation		±15sec/month(25℃) (±4sec/week)
Memory protection		Over 5 years(at 25℃)
Control Output	Contact type	SPDT(Single Pole Double Contact)
	Contact capacity	250VAC 10A resistive load
	Output number	Independent 2 output(1c × 2)
Relay life cycle	Mechanical	Min. 5,000,000 operations(Switching capacity 30 times/minute)
	Electrical	50,000 operations<Switching capacity 20 times/1 minute, at 250VAC 10A(resistive load)>
Insulation resistance		Min. 100MΩ(at 500VDC mega)
Dielectric strength		2000VAC 50/60Hz for 1minute
Noise strength		±2kV the square wave noise(pulse width:1μs) by the noise simulator
Ambient temperature		-10 ~ 55℃(at non-freezing status)
Storage temperature		-25 ~ 65℃(at non-freezing status)
Ambient humidity		35 ~ 85%RH
Unit weight		Approx. 270g

(A) Counter

(B) Timer

(C) Temp. controller

(D) Power controller

(E) Panel meter

(F) Tacho/Speed/Pulse meter

(G) Display unit

(H) Sensor controller

(I) Switching power supply

(J) Proximity sensor

(K) Photo electric sensor

(L) Pressure sensor

(M) Rotary encoder

(N) Stepping motor & Driver & Controller

(O) Graphic panel

(P) Production stoppage models & replacement

LE7M-2

Connections

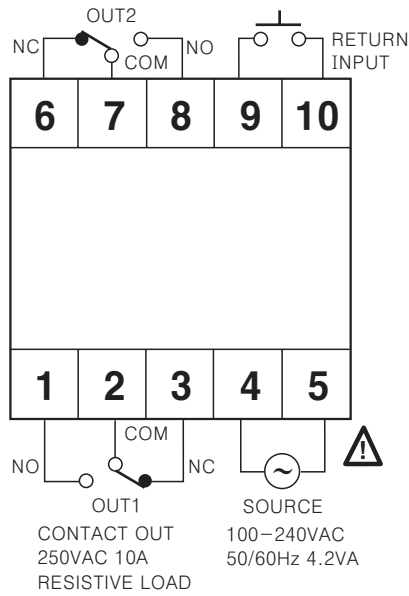

Load connection

Please connect surge absorber (R+C) to the both ends to control non-resistive load (Ex: Magnetic switch etc).

- In case of controlling the load directly

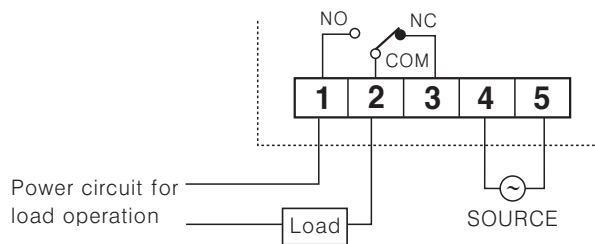

- In case of controlling the load by using a magnetic switch

[Single phase]

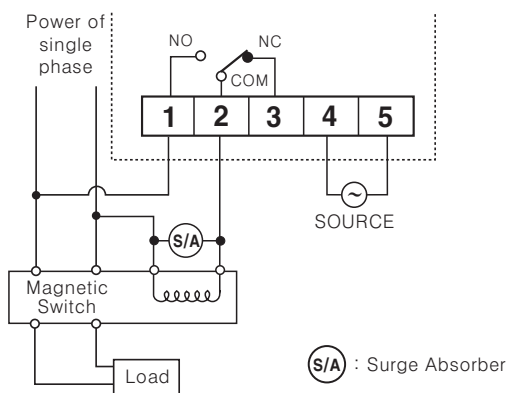

[Three phase]

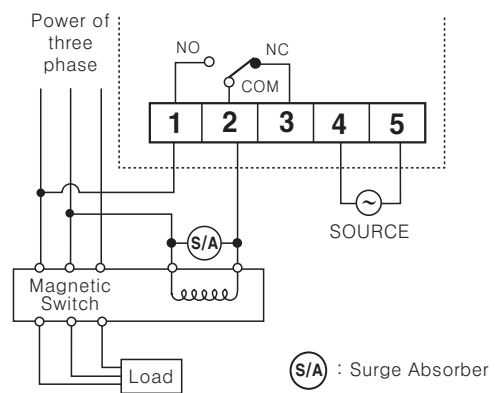

Weekly/Yearly Timer

Dimensions & Mounting

1) Front panel mounting

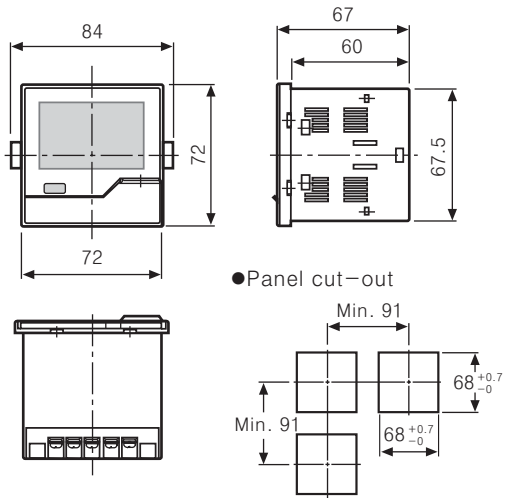

2) Surface mounting

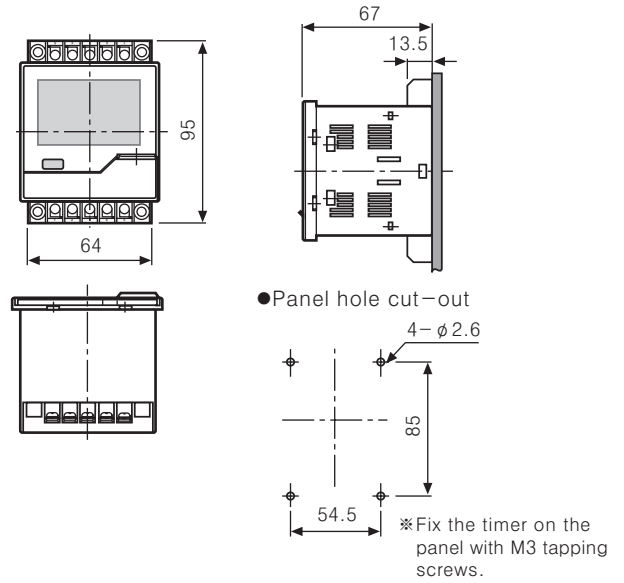

3) DIN Rail mounting

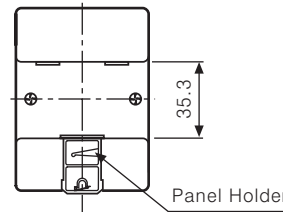
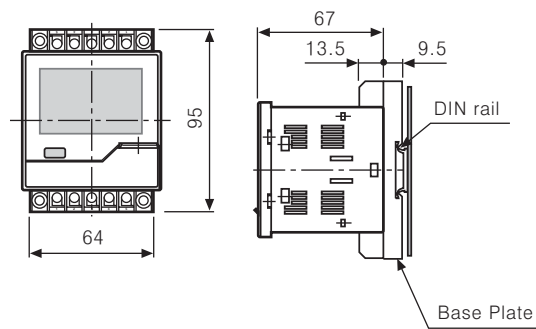

(Unit:mm)

How to switch from the flush mounting to surface mounting type

Remove terminals from the body after unscrewing terminal screws, and then assemble terminals to the body after rotating terminals as shown below.

① Unscrew 4bolts from terminal block.

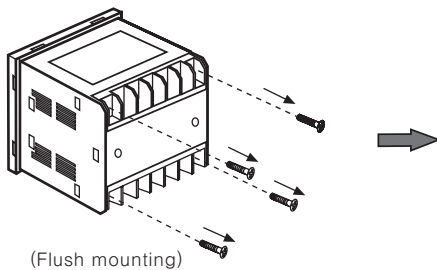

② Detach terminal block from case and then rotate it 180 degree.

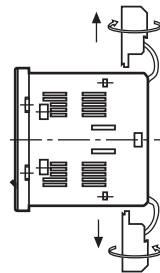

③ Assemble terminal block to case by using the 4 bolts.

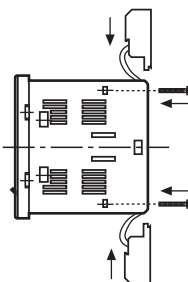
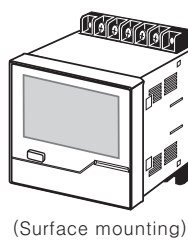

(A) Counter

(B) Timer

(C) Temp. controller

(D) Power controller

(E) Panel meter

(F) Tacho/ Speed/ Pulse meter

(G) Display unit

(H) Sensor controller

(I) Switching power supply

(J) Proximity sensor

(K) Photo electric sensor

(L) Pressure sensor

(M) Rotary encoder

(N) Stepping motor & Driver & Controller

(O) Graphic panel

(P) Production stoppage models & replacement

Front panel identification

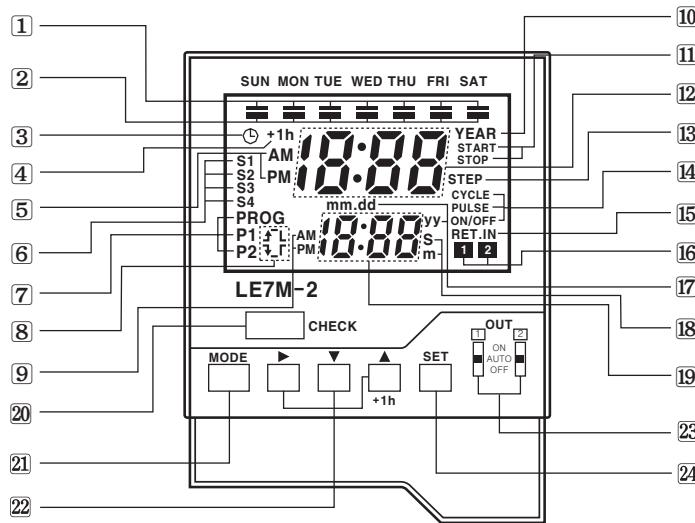

- | | |
|--|--|
| <ul style="list-style-type: none"> ① Day indicator ② Day display <ul style="list-style-type: none"> ●Light : Day is selected. ●Light-out : Day is not selected. ③ Current time setting mode indicator ④ DST display(Daylight Saving Time) ⑤ AM/PM display ⑥ Season display ⑦ Program display ⑧ Display ON time/day, OFF time/day, ON time width, OFF time width ⑨ AM/PM display ⑩ YEAR display : It is lighted when set, check, modify, delete yearly program, set yearly holidays and operate yearly program. ⑪ Yearly START/STOP day display ⑫ Main display | <ul style="list-style-type: none"> ⑬ Remaining step display ⑭ Operation mode display ⑮ Power restore input display ⑯ Output mode display ⑰ Year, month, date display ⑱ Unit of pulse width display ⑲ Sub-display ⑳ CHECK Key ㉑ MODE Key ㉒ Operation key ㉓ Output selection switch <ul style="list-style-type: none"> ●AUTO : Control output according to the set program. ●ON : Output is ON.(Operation) ●OFF : Output is OFF. ※Output 1(OUT1) and Output 2(OUT2) are selected independently. ㉔ SET Key |
|--|--|

Functions

- Program setting and output operation
 - Output1/Output2 operates according to Program1 and Program2.
- Definitions
 - Record : A part of program that controls output operation.
 - Step : Basic component of Record.
- Operation modes

If the operation mode of Program1 (Program2) is set on Pulse mode initially, the Pulse mode is fixed for additional programs.

If the operation mode of Program1 (Program2) is set on ON/OFF or Cycle mode initially, Pulse mode cannot be used for additional programs.

 - Weekly ON/OFF mode
 - Output operation by ON/OFF set time.

- Min. time setting unit : 1 min.
- Able to set ON/OFF day separately.
- One Record in two Steps(ON day/ON time, OFF day/OFF time)



- Weekly Cycle mode
 - Output turns ON for ON time and turns OFF for OFF time. And the ON/OFF cycle is repeated.
 - Range of ON/OFF time : 1 min.~12:59
 - One Record in three Steps(ON day/ON time, OFF day/OFF time, ON width/OFF width)

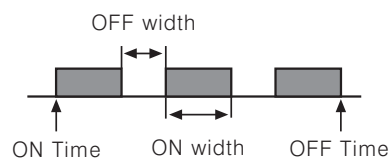

■ Functions

◎ Programs

● Weekly Pulse mode

Output turns ON at ON time for a specified pulse width. (Pulse width : 1~59sec, 1~60min)

- One Record in two Steps (ON day/ON time, Pulse width)

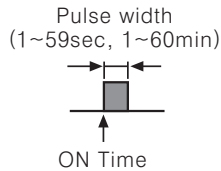

● Yearly ON/OFF mode

Output turns ON at ON time on START date and turns OFF at OFF time on STOP date.

- One Record in three Steps (START/STOP date, ON/OFF time)

● Yearly Pulse mode

Output turns ON at ON time on START date and turns OFF at OFF time on STOP time for a specified pulse width repeatedly. (Pulse width: 1~59sec, 1~60min).

- One Record in three Steps (START/STOP date, ON time, Pulse width)

◎ Program operation

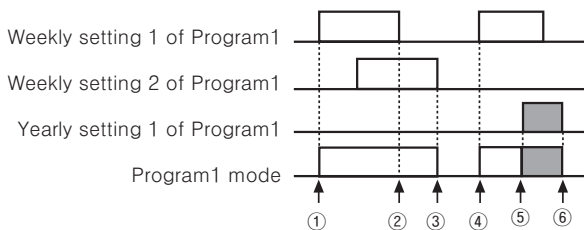

- ① ~ ② : Operated by weekly setting 1 of Program 1.
- ② ~ ③ : Operated by weekly setting 2 of Program 1.
- ④ ~ ⑤ : Operated by weekly setting 1 of Program 1.
- ⑤ ~ ⑥ : Operated by yearly setting 1 of Program 1.

(During weekly program operation at 12:00 AM on START date, the weekly program operation stops, and it changes to yearly program operation mode. The yearly program operation stops at 12:00 AM on the next day of STOP date.)

◎ Display and change of next mode

- The day of next mode in Program1 or Program2 is displayed on the day indicator, and the time of next mode is displayed on the lower row of screen. Press **[SET] + [CHECK]** in RUN mode it is changed from program1 to program2 or from program2 to program1.

- In ON/OFF operation mode, set ON time and OFF time to next mode. In Pulse operation mode, set Pulse ON time to next mode.

◎ Power restore mode

In setting group 2–Level 2 (Power Restore), select Auto ("RL") or Normal ("nor") by **[▲]** or **[▼]** keys, and press **[SET]** key to set.

●Auto ("RL") power restore mode

Output (OUT1, OUT2) operates according to program when power turns on again after power failure.

●Normal ("nor") power restore mode

When power turns on again after power failure, output is kept OFF and "RET.IN" flashes on the panel. When Power Restore input is detected, "RET.IN" turns off and output operates according to program.

●Power restore input

Input contact signal in external "Return Input terminals (⑨~⑩)" by switch or relay, or press **[SET]** key for 3sec in RUN mode.

Please use reliable contacts enough to flow 0.1mA of current at 5VDC when use switch or relay.

◎ Season switching mode

In setting group 2–Level ("SEn" is lighted, "oFF" is flashed.), select ON ("on") by **[▲]** or **[▼]** key Press **[SET]** key to set.

***Note : When the season switching mode changed from "oFF" to "on" or vice versa, previous set programs are deleted.**

●ON ("on") mode

Weekly program is switched automatically by season switching.

- Period setting per season

① Press **[SET]** key in period setting per season mode of setting group 2. ("SEn" is flashed, season with preset period is lighted and "START" and "STOP" are lighted.)

② Advance to the flashing position of season selection among S1, S2, S3, S4 by **[▲]** or **[▼]** keys and press **[SET]** key.

③ After set **START** month, date per season and press **[SET]** key.

④ **[SET]** key is pressed after set **STOP** month, date per season, it is advanced to LEVEL1 of period setting per season. Add or adjust the period setting by **[SET]** key.

- It is disable to use when it is OFF ("oFF").

◎ Daylight Saving Time

In setting group 2–LEVEL 2 ("dSt" is lighted, "RL" or "nor" is flashed.), select Auto ("RL") or Normal ("nor") by **[▲]** or **[▼]** keys. press **[SET]** key to set.

(A) Counter

(B) Timer

(C) Temp. controller

(D) Power controller

(E) Panel meter

(F) Tacho/Speed/Pulse meter

(G) Display unit

(H) Sensor controller

(I) Switching power supply

(J) Proximity sensor

(K) Photo electric sensor

(L) Pressure sensor

(M) Rotary encoder

(N) Stepping motor & Driver & Controller

(O) Graphic panel

(P) Production stoppage models & replacement

■ Functions

● Auto("RL") Daylight Saving Time mode

Current time will be faster as an hour when it is started and slower as an hour when it is finished.

- Automatic Daylight Saving Time period setting

① Automatic Daylight Saving Time period setting LEVEL 1 of setting group 2.

("dSt" is flashed and "START" and "STOP" are lighted.)

② Set START date (Month, date) of automatic Daylight Saving Time mode and press **SET** key.

③ Set START time (AM/PM, Hour) of automatic Daylight Saving Time mode and press **SET** key. But, the minute will be fixed as 00.

④ Set STOP date (Month, date) of automatic Daylight Saving Time mode and press **SET** key.

⑤ Set STOP time (AM/PM, Hour) of automatic Daylight Saving Time mode and press **SET** key. But, the minute will be fixed as 00.

● Normal("nor") Daylight Saving Time mode

Press **+1h** key over 3sec in RUN mode, "+1h" is lighted and current time is faster as an hour and "+1h" is lighted out or vice versa, when press **+1h** key over 3sec again.

◎ Current time setting

(Ex) Set the current time as 10, Mar, 2008, 5:10 PM.

① Advance to the current time setting mode

SUN MON TUE WED THU FRI SAT



MODE + **SET** keys are pressed over 3sec in RUN mode, it is advanced to current time setting of setting group 2 and clock will be flashed and t.AJ will be lighted in second display part, press **SET** key.

② Year, Month, Date setting

SUN MON TUE WED THU FRI SAT



Press **▲** or **▼** keys to set 08 (year 2008) and move the flashing digit to position month by **▶** key.

Press **SET** key after press **▲** or **▼** keys to set date 10.

③ Current time (AM, PM) setting

SUN MON TUE WED THU FRI SAT



Press **▲** or **▼** keys to select PM and move the flashing digit to position hour by **▶** key.

④ Current time (Hour, Min.) setting

SUN MON TUE WED THU FRI SAT

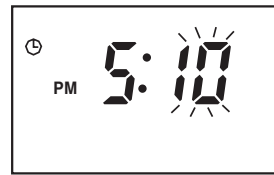

Press **▲** or **▼** keys to set 5 PM and move the flashing digit to position min. by **▶** key. Press **▲** or **▼** key to set 10min and press **SET** key and it is returned to RUN mode when press **MODE** key over 3sec.

● It advances to "① Current time setting mode" in ON status and set current time as shown above ②~④ by **SET** key.

● Current time is set up to 31, Dec, 2099.

● Check current year/month/date in RUN mode. When **▶** key is pressed over 3sec in RUN mode, it advances to current year/month/date display. After display current year/month/date for 3sec, it returns to RUN mode displaying current display.

Weekly/Yearly Timer

■ Program setting

◎ Setting group 1

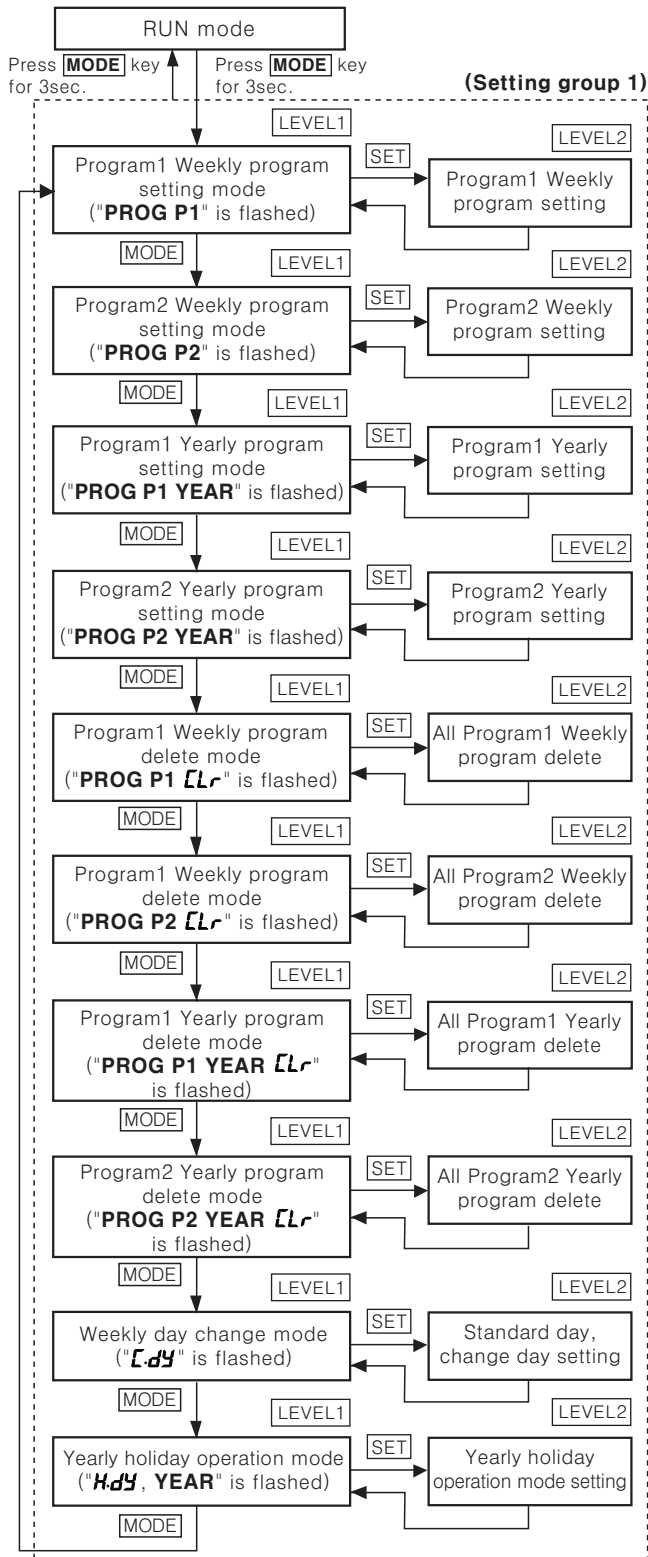

- When it advances to setting group 1 in RUN mode, output (OUT1, OUT2) will be OFF.
- It returns to previous setting group 1 when power of time switch is ON again in setting group 1.
- When **MODE** key is pressed in LEVEL2 of setting group 1, current setting will be canceled and it returns to previous LEVEL1.

◎ Setting group 2

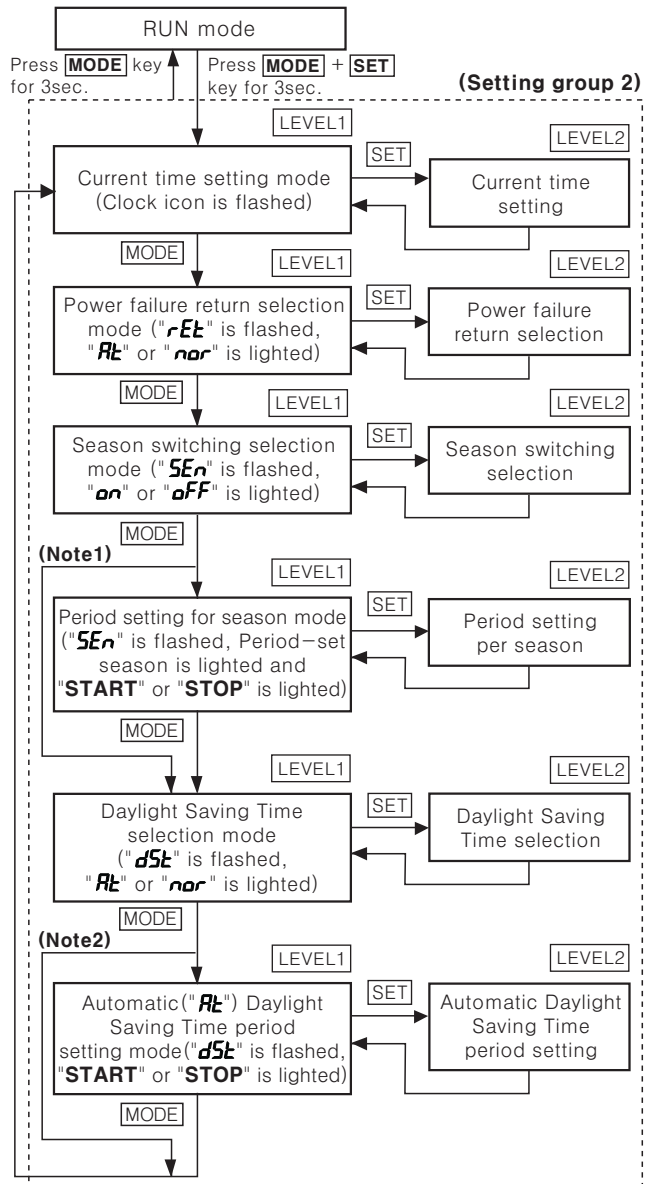

- (Note1) Season switching selection is "oFF".
- (Note2) Automatic switching selection of Daylight Saving Time is Normal ("nor").
- When it advances to setting group 2 in RUN mode, output(OUT1, OUT2) will be OFF.
- When power of time switch is ON again in setting group 2, it returns to previous setting group 1.
- Front **MODE** key is pressed in LEVEL2 of setting group 2, it returns to previous LEVEL1.
- When season switching selection is changed from "oFF" to "on" or "on" to "oFF", previous set weekly program will be deleted.

(A)	Counter
(B)	Timer
(C)	Temp. controller
(D)	Power controller
(E)	Panel meter
(F)	Tacho/Speed/Pulse meter
(G)	Display unit
(H)	Sensor controller
(I)	Switching power supply
(J)	Proximity sensor
(K)	Photo electric sensor
(L)	Pressure sensor
(M)	Rotary encoder
(N)	Stepping motor & Driver & Controller
(O)	Graphic panel
(P)	Production stoppage models & replacement

Program setting

Weekly program setting

Weekly ON/OFF mode

(Ex) Output1 (OUT1) is ON from Monday to Friday at 8:00 AM and OFF at 6:10 PM.

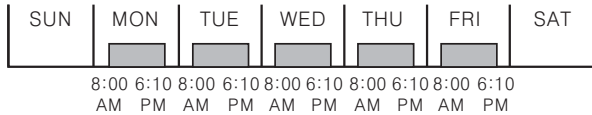

① Advance to program1(P1) weekly program setting mode

SUN MON TUE WED THU FRI SAT

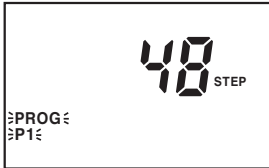

MODE key is pressed over 3sec in RUN mode, "PROG P1" is flashed and press **SET** key.

② Mode type setting

SUN MON TUE WED THU FRI SAT

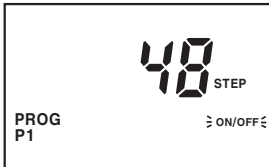

Press **SET** key in ON/OFF mode.

③ ON day setting

SUN MON TUE WED THU FRI SAT

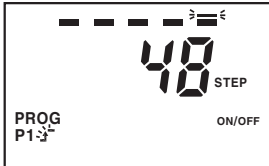

Press **▶** key to move the indicator to Monday, it will be lighted when **▲** or **▼** keys are pressed and move it to Tuesday by **▶** key.

Press **SET** key after Tuesday, Wednesday, Thursday, Friday are lighted.

④ ON time setting(AM, PM)

SUN MON TUE WED THU FRI SAT

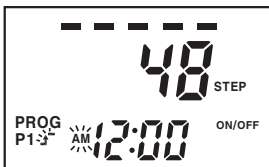

▶ key is pressed, move the flashing to hour position and select PM by **▲** or **▼** keys when ON time is afternoon.

⑤ ON time setting(Hour, Minute)

SUN MON TUE WED THU FRI SAT

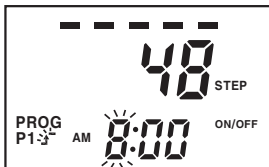

Set 8:00 by **▼** key and press **SET** key.

⑥ OFF day setting

SUN MON TUE WED THU FRI SAT

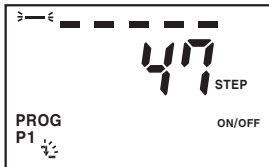

Press **SET** key to check ON/OFF day.

⑦ OFF time setting(AM, PM)

SUN MON TUE WED THU FRI SAT



Select PM by **▲** or **▼** keys and move the flashing to hour position by **▶** key.

⑧ OFF time setting(Hour, Minute)

SUN MON TUE WED THU FRI SAT

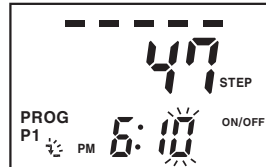

Move the flashing to minute position after set 6:00 by **▲** key and set the minute as 10 and press **SET** key.

⑨ Complete to set

SUN MON TUE WED THU FRI SAT



Press **SET** key to set additional program.

Weekly Pulse mode

Output2(OUT2) is ON for 10sec at 8:00AM from Monday to Friday during S2 season in case, period of S1, S2, S3, S4 is set.

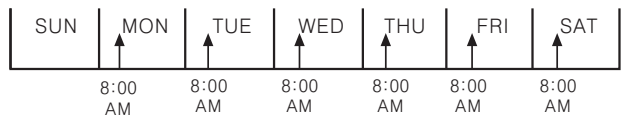

ON for 10sec

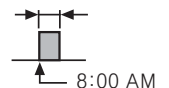

① Program2(P2) Advance to weekly program setting mode

SUN MON TUE WED THU FRI SAT

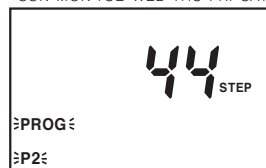

MODE key is pressed for 3sec in RUN mode, "PROG P1" is flashed and press **MODE** key again, "PROG P2" is flashed and press **SET** key.

② Mode type setting

SUN MON TUE WED THU FRI SAT



Press **▲** key when ON/OFF is flashed, PULSE is flashed and press **SET** key.

③ Season selection

SUN MON TUE WED THU FRI SAT



Press **▼** key to select season S2 and press **SET** key.

Weekly/Yearly Timer

Program setting

④ ON day setting

SUN MON TUE WED THU FRI SAT



Press **▶** key to move the indicator to Monday, it will be lighted when **▲** or **▼** keys are pressed and move it to Tuesday by **▶** key. Press **SET** key after light Tuesday, Wednesday, Thursday and Friday.

⑤ ON time setting (AM, PM)

SUN MON TUE WED THU FRI SAT



Press **▶** key, move the flashing to hour position and select PM by **▲** or **▼** keys when ON time is afternoon.

⑥ ON time setting (Hour, Minute)

SUN MON TUE WED THU FRI SAT



Set 8:00 by **▼** key and press **SET** key.

⑦ Pulse width setting

SUN MON TUE WED THU FRI SAT

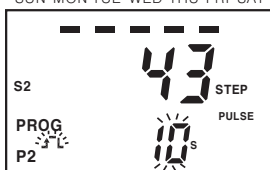

Press **▲** key to select pulse width as 10s(10sec.) and press **SET** key.

⑧ Complete to set

SUN MON TUE WED THU FRI SAT



Press **SET** key to set additional program.

● Weekly Cycle mode

(Ex) Output1 (OUT1) is ON for 10min and OFF for 5min from Monday 6:00AM to Saturday 5:30PM.



① Advance to Program1 (P1) weekly program setting mode

SUN MON TUE WED THU FRI SAT



Press **MODE** key for 3sec in RUN mode, "PROG P1" is flashed.

② Mode type setting

SUN MON TUE WED THU FRI SAT

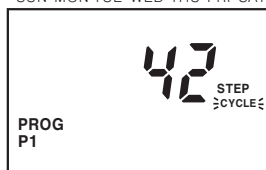

Press **▲** key when ON/OFF is flashed, CYCLE is flashed and press **SET** key.

③ ~ ⑧

Refer to ③~⑧ of "●Weekly ON/OFF mode" to set ON day, ON time, OFF day and OFF time.

⑨ ON time width setting

SUN MON TUE WED THU FRI SAT



Press **▶** key to move the indicator to Saturday and press **SET** key after select Saturday as standard day (SAT is flashed).

⑩ OFF time width setting

SUN MON TUE WED THU FRI SAT



Press **▶** key to move the flashing to minute position and set as 5min by **▲** key and press **SET** key.

⑪ Complete to set

SUN MON TUE WED THU FRI SAT



Press **SET** key to set additional program.

◎ Weekly day change

It operates when the specified day mode is required to install in other day from the set day and it returns to previous program setting automatically when it is finished.

It is applied to program1 (P1) and program2 (P2).

● Weekly day change cancellation

- ① Change current year, month, date in current time setting mode
- ② Change standard day
- ③ Delete all program in program1 (P1) and program2 (P2)
- ④ Season switching

● Setting example

Output1 (OUT1) is ON in Saturday at 9:00AM and OFF at 12:00PM and it is ON 8:30AM and OFF at 6:00PM from Monday to Friday and the mode of Monday and Tuesday is operated temporarily as Saturday (standard) program.

(A) Counter

(B) Timer

(C) Temp. controller

(D) Power controller

(E) Panel meter

(F) Tacho/Speed/Pulse meter

(G) Display unit

(H) Sensor controller

(I) Switching power supply

(J) Proximity sensor

(K) Photo electric sensor

(L) Pressure sensor

(M) Rotary encoder

(N) Stepping motor & Driver & Controller

(O) Graphic panel

(P) Production stoppage models & replacement

■ Program setting

① Advance to weekly day change mode

SUN MON TUE WED THU FRI SAT



Press **MODE** key over 3sec to move to the setting group1 in RUN mode and press it repeatedly until "L.dY" is flashed in second display part and press **SET** key.

② Standard day selection

SUN MON TUE WED THU FRI SAT



Press **▶** key to move the indicator to Saturday and press **SET** key. after select Saturday as standard day(Sat is lighted) by **▲** or **▼** keys.

③ Change day selection

SUN MON TUE WED THU FRI SAT



Press **▶** key to move the indicator to Monday and select Monday to change(Mon is lighted) by **▲** or **▼** keys and repeat the procedure to select Tuesday to change (Tue is lighted) and press **SET** key to complete.

◎ Yearly holiday mode

It operates to off the output without program adjustment during previously set yearly holiday period available from present year to 31, Dec of the next year.

Designate the start date of yearly holiday and year of end date as every year ("--") to repeat the holiday mode for specified in every year.

● Setting example

Set every year 5, May to off the output(OUT1, OUT2).

① Advance to yearly holiday mode

SUN MON TUE WED THU FRI SAT



Press **MODE** key over 3sec to move to the setting group1 in RUN mode and press it repeatedly until "H.dY" is flashed in second display part and press **SET** key.

② Yearly holiday No. display

SUN MON TUE WED THU FRI SAT



Press **SET** key after check yearly holiday No.

③ Start date of yearly holiday setting

SUN MON TUE WED THU FRI SAT

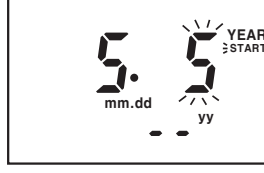

Press **▶** key until month position is flashed and set May by **▲** key and press **▶** key until date position is flashed. Press **SET** key after set 5th by **▲** key.

④ End date of yearly holiday setting

SUN MON TUE WED THU FRI SAT

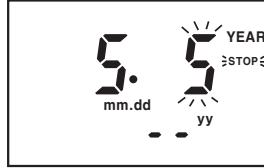

The flashing is moved to month position directly and press **▲** key to set May and press **▶** key until date position is flashed. Press **SET** key after set 5th by **▲** key.

⑤ Complete to yearly holiday

SUN MON TUE WED THU FRI SAT



Press **MODE** key to finish the additional yearly holiday setting and press **SET** key to set.

※It is able to set yearly holiday up to 12 times.

◎ Yearly program setting

● Yearly ON/OFF mode

(Ex)Output1(OUT1) is ON from every 5, Apr to 7, Apr at 9:00AM and OFF 5:10PM.

① Advance to Program1(P1) yearly program setting mode

SUN MON TUE WED THU FRI SAT

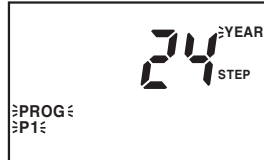

Press **MODE** key for 3sec in RUN mode, "PROG P1" is flashed and press **MODE** key 3 times more until "PROG P2 YEAR" is flashed and press **SET** key.

② Mode type setting

SUN MON TUE WED THU FRI SAT

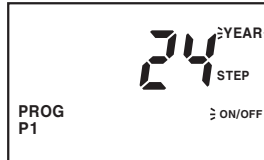

Press **SET** key when ON/OFF is flashed.

③ Start date setting

SUN MON TUE WED THU FRI SAT

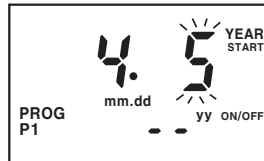

Press **▶** key until month position is flashed and set Apr by **▲** key and press **▶** key until date position is flashed. Press **SET** key after set 5th by **▲** key.

Weekly/Yearly Timer

Program setting

④ End date setting

SUN MON TUE WED THU FRI SAT

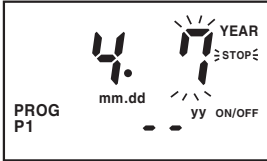

The flashing is moved to month position directly and press **▲** key to set Apr and press **▶** key until date position is flashed.

Press **SET** key after set 7th by **▲** key.

⑤ ON time setting(AM, PM)

SUN MON TUE WED THU FRI SAT



▶ key is pressed, move the flashing to hour position and select PM by **▲** or **▼** keys when ON time is afternoon.

⑥ ON time setting(Hour, Minute)

SUN MON TUE WED THU FRI SAT



Press **▼** key to set 9 and press **SET** key after check 00min.

⑦ OFF time setting(AM, PM)

SUN MON TUE WED THU FRI SAT



Select PM by **▲** or **▼** keys and move the flashing to hour position by **▶** key.

⑧ OFF time setting(Hour, Minute)

SUN MON TUE WED THU FRI SAT

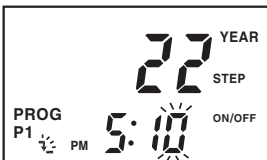

Move the flashing to minute position after set 5 by **▲** key and set the minute as 10 and press **SET** key.

⑨ Complete to set

SUN MON TUE WED THU FRI SAT



Press **SET** key to set additional program.

● Yearly Pulse mode

(Ex) Output2(OUT2) is ON from 2, Oct, 2008 to 4, Oct, 2008 at 10:00AM and OFF after 5sec. (Present is 2007.)

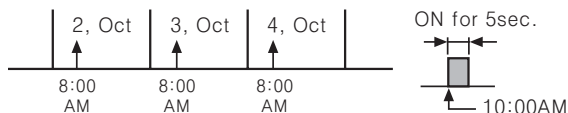

① Advance to Program2(P2) yearly program setting mode

SUN MON TUE WED THU FRI SAT

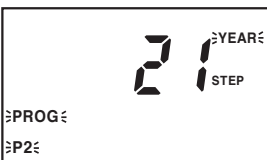

MODE key is pressed for 3sec in RUN mode, "PROG P1" is flashed and press **MODE** key again, "PROG P2 YEAR" is flashed and press **SET** key.

② Mode type setting

SUN MON TUE WED THU FRI SAT



▲ key is pressed when ON/OFF is flashed to set PULSE mode and press **SET** key.

③ Start date setting

SUN MON TUE WED THU FRI SAT

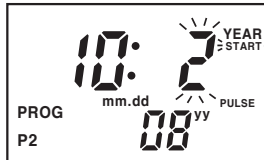

Press **▲** key twice to set 08(year 2008) and move to month position by **▶** key.

Set Oct by **▼** key and move to date position by **▶** key and press **SET** key after set 2nd by **▲** key.

④ End date setting

SUN MON TUE WED THU FRI SAT

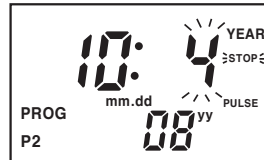

The flashing is moved to month position directly by **▶** key and set 4th by **▲** key after move it to date position by **▶** key, then press **SET** key.

⑤ ON time setting(AM, PM)

SUN MON TUE WED THU FRI SAT



▶ key is pressed, move the flashing to hour position and select PM by **▲** or **▼** keys when ON time is afternoon.

⑥ ON time setting(Hour, Minute)

SUN MON TUE WED THU FRI SAT



Press **▼** key twice to set 10 and press **SET** key after check 00min.

⑦ Pulse width setting

SUN MON TUE WED THU FRI SAT

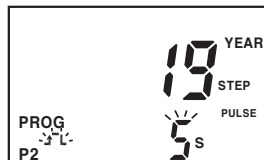

Press **▲** key 4 times to select pulse width as 5s and press **SET** key.

⑧ Complete to set

SUN MON TUE WED THU FRI SAT



Press **SET** key to set additional program.

※It is able to set year of start/end date in yearly program setting up to 2 years later from the present year.

(A) Counter

(B) Timer

(C) Temp. controller

(D) Power controller

(E) Panel meter

(F) Tacho/Speed/Pulse meter

(G) Display unit

(H) Sensor controller

(I) Switching power supply

(J) Proximity sensor

(K) Photo electric sensor

(L) Pressure sensor

(M) Rotary encoder

(N) Stepping motor & Driver & Controller

(O) Graphic panel

(P) Production stoppage models & replacement

■ Program check, modify and delete

◎ Weekly program check, modify and delete

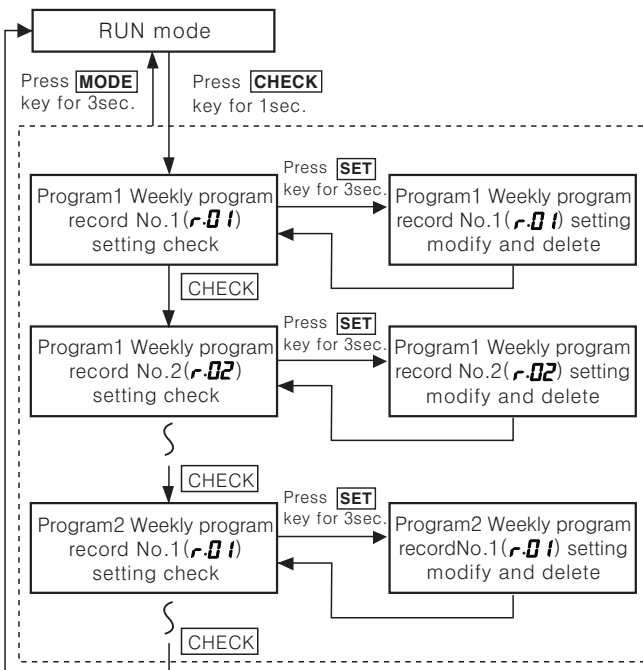

◎ Yearly program check, modify and delete

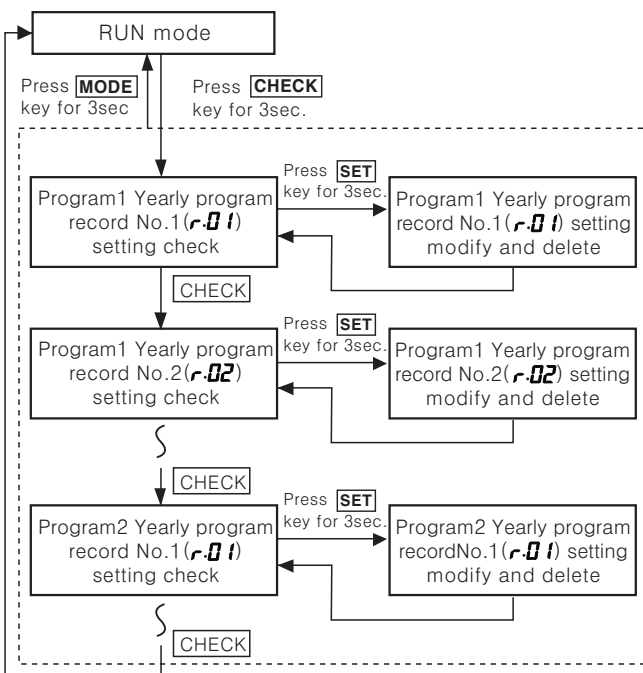

※ "YEAR" is lighted when check, modify or delete yearly program.

- If any key is untouched for 60sec, it is returned to RUN mode in weekly or yearly program check.
- In weekly or yearly program check, it controls output according to program setting and output is OFF in modify or delete mode.
- When MODE key is pressed in weekly or yearly program record modify, delete stand by or delete mode, current work is cancelled and it is returned to check mode.
- Weekly or yearly program record modify and delete

(1) Program record modify

- ① When press SET key over 3sec in program check, "Edt" is flashed in second display part, press SET key.
- ② It returns to check mode when finish the modify same as the above procedure.

(2) Program record delete

- ① When press SET key over 3sec in program check, "Edt" is flashed in second display part, press ▲ or ▼ keys until "CLR" is flashed in second display part and press SET key.
- ② Press SET key over 3sec when "CLR" is lighted in second display part, it returns to program check.